

Note to other teachers and users of these slides: We would be delighted if you found our material useful for giving your own lectures. Feel free to use these slides verbatim, or to modify them to fit your own needs. If you make use of a significant portion of these slides in your own lecture, please include this message, or a link to our web site: <http://cs224w.Stanford.edu>

Stanford CS224W: GNN Augmentation and Training

CS224W: Machine Learning with Graphs
Jure Leskovec, Stanford University
<http://cs224w.stanford.edu>



Announcements

- **Deadline extension for Colab 1 and project proposal**
 - Colab 1 due date extended to Tuesday, October 17
 - Project proposal due date extended to Tuesday, October 24
- **Homework 1**
 - Due Thursday, October 19 (1 week from now)
 - Recitation session on 1pm-3pm, Friday, October 13
 - Details on Ed
- Project information released on course website

Course project

- **Goal:** create long-lasting resources for your technical profiles + broader graph ML community
- Three types of projects
 - 1) Real-world applications of GNNs
 - 2) Tutorial on PyG functionality
 - 3) Implementation of cutting-edge research
- We will publish your blog posts on our course's [Medium page!](#)

1) Real-world applications of GNNs

- **Goal:** identify a specific use case and demonstrate how GNNs and PyG can be used to solve this problem
- **Output:** blog post, Google colab
- Example use cases
 - Fraud detection
 - Predicting drug interactions
 - Friend recommendation
- Check out the [featured posts](#) in the project information doc on the course website

2) Tutorial on PyG functionality

- **Goal:** develop a tutorial that explains how to use existing PyG functionality
- **Output:** blog post, Google colab
- Example topics for tutorials
 - PyG's [explainability](#) module
 - Methods for graph sampling (e.g., negative sampling, sampling on heterogeneous graphs)
 - Tutorial on [GraphGym](#), a platform for designing and evaluating GNNs
- Check out [example tutorials](#) from PyG

3) Implementation of research

- **Goal:** implement interesting methods from a recent research paper in graph ML
- **Output:** PR to PyG [contrib](#), short blog post
- Project details
 - Implementation should include comprehensive testing and documentation on new functionality
 - Try to build on existing PyG and PyTorch code wherever possible
 - Note: this project is more manageable if you are already comfortable with PyTorch and deep learning. We also highly recommend group of 3.

Project logistics

- Project is worth 30% of your course grade
 - Project proposal (2 pages), due October 24
 - Project milestone, due November 9
 - Final reports, due December 14
- We recommend groups of 3, but groups of 2 are also allowed
 - Each group will be assigned a CA mentor who will provide feedback
- **Full project description is released on the [course website!](#)**

Stanford CS224W: GNN Augmentation and Training

CS224W: Machine Learning with Graphs

Jure Leskovec, Stanford University

<http://cs224w.stanford.edu>



Recap: A General GNN Framework

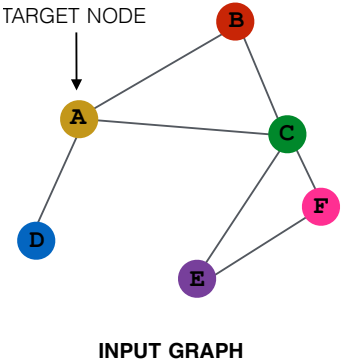

(5) Learning objective

(3) Layer connectivity

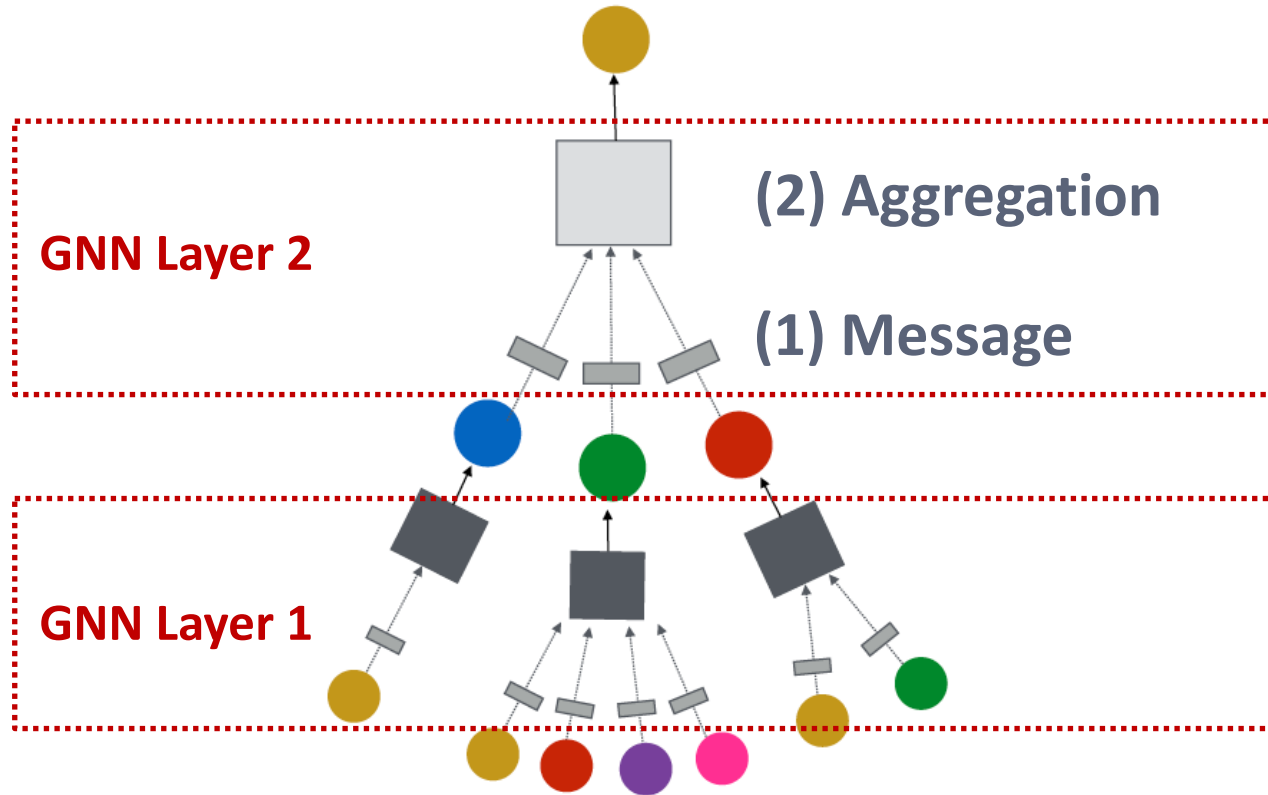

(4) Graph augmentation

Recap: A Single GNN Layer

- **Putting things together:**

- **(1) Message:** each node computes a message

$$\mathbf{m}_u^{(l)} = \text{MSG}^{(l)} \left(\mathbf{h}_u^{(l-1)} \right), u \in \{N(v) \cup v\}$$

- **(2) Aggregation:** aggregate messages from neighbors

$$\mathbf{h}_v^{(l)} = \text{AGG}^{(l)} \left(\left\{ \mathbf{m}_u^{(l)}, u \in N(v) \right\}, \mathbf{m}_v^{(l)} \right)$$

- **Nonlinearity (activation):** Adds expressiveness

- Often written as $\sigma(\cdot)$: $\text{ReLU}(\cdot)$, $\text{Sigmoid}(\cdot)$, ...
- Can be added to **message or aggregation**

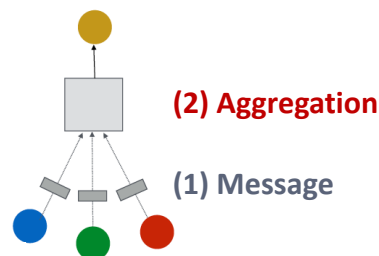

Recap: GNN Layer Connectivity

- **What if my problem still requires many GNN layers?**
- **Lesson 2: Add skip connections in GNNs**
 - **Observation from over-smoothing:** Node embeddings in earlier GNN layers can sometimes better differentiate nodes
 - **Solution:** We can increase the impact of earlier layers on the final node embeddings, **by adding shortcuts in GNN**

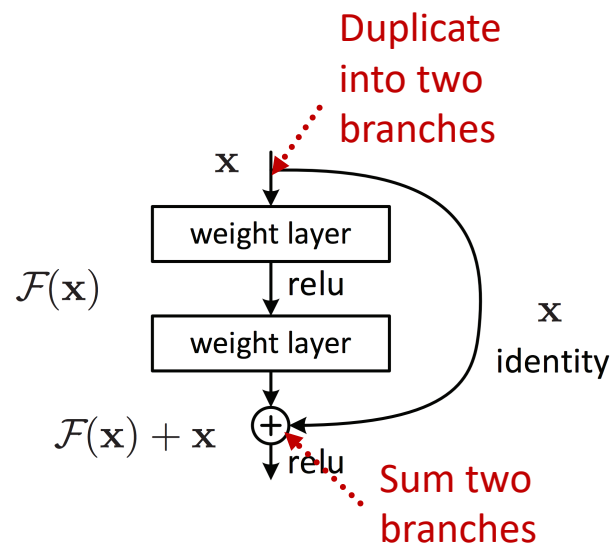
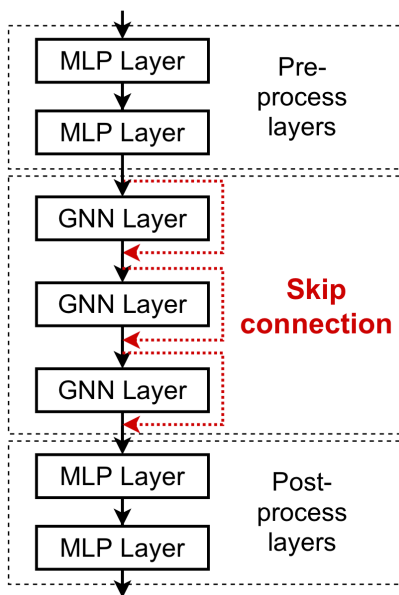

Idea of skip connections:

Before adding shortcuts:

$$\mathbf{F}(\mathbf{x})$$

After adding shortcuts:

$$\mathbf{F}(\mathbf{x}) + \mathbf{x}$$

Recap: Graph Manipulation

- **Graph Feature manipulation**
 - The input graph **lacks features** → **feature augmentation**
- **Graph Structure manipulation**
 - The graph is **too sparse** → **Add virtual nodes / edges**
 - The graph is **too dense** → **Sample neighbors when doing message passing**
 - The graph is **too large** → **Sample subgraphs to compute embeddings**
 - Will cover later in lecture: Scaling up GNNs

Feature Augmentation on Graphs

Why do we need feature augmentation?

- **(2) Certain structures are hard to learn by GNN**
- Other commonly used augmented features:
 - Degree distribution
 - Clustering coefficient
 - PageRank
 - Centrality
 - ...
- **Any feature we have introduced can be used!**

Add Virtual Nodes / Edges

- **Motivation:** Augment sparse graphs
- **(1) Add virtual edges**
 - **Common approach:** Connect 2-hop neighbors via virtual edges
 - **Intuition:** Instead of using adj. matrix A for GNN computation, use $A + A^2$

- **Use cases:** Bipartite graphs
 - Author-to-papers (they authored)
 - 2-hop virtual edges make an author-author collaboration graph

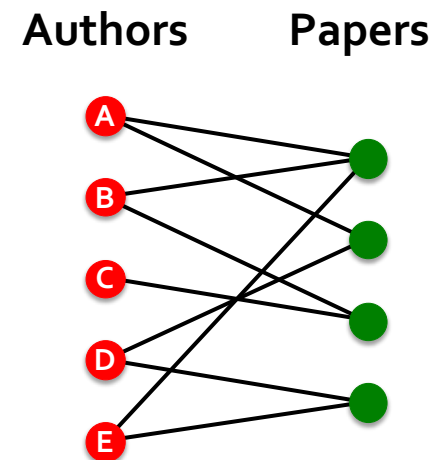

Add Virtual Nodes / Edges

- **Motivation:** Augment sparse graphs
- **(2) Add virtual nodes**
 - The virtual node will connect to all the nodes in the graph
 - Suppose in a sparse graph, two nodes have shortest path distance of 10
 - After adding the virtual node, **all the nodes will have a distance of 2**
 - Node A – Virtual node – Node B
 - **Benefits:** Greatly **improves message passing in sparse graphs**

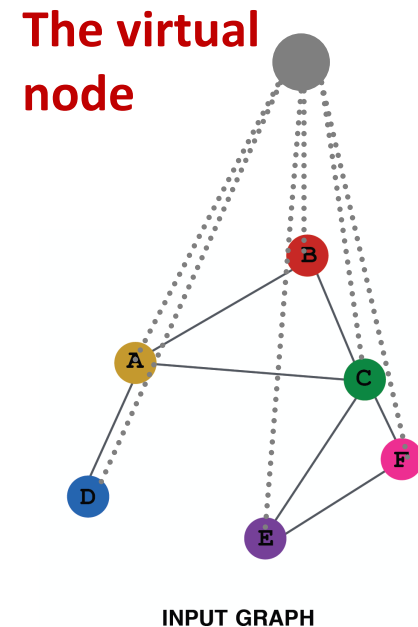

Node Neighborhood Sampling

- **Previously:**
 - All the nodes are used for message passing

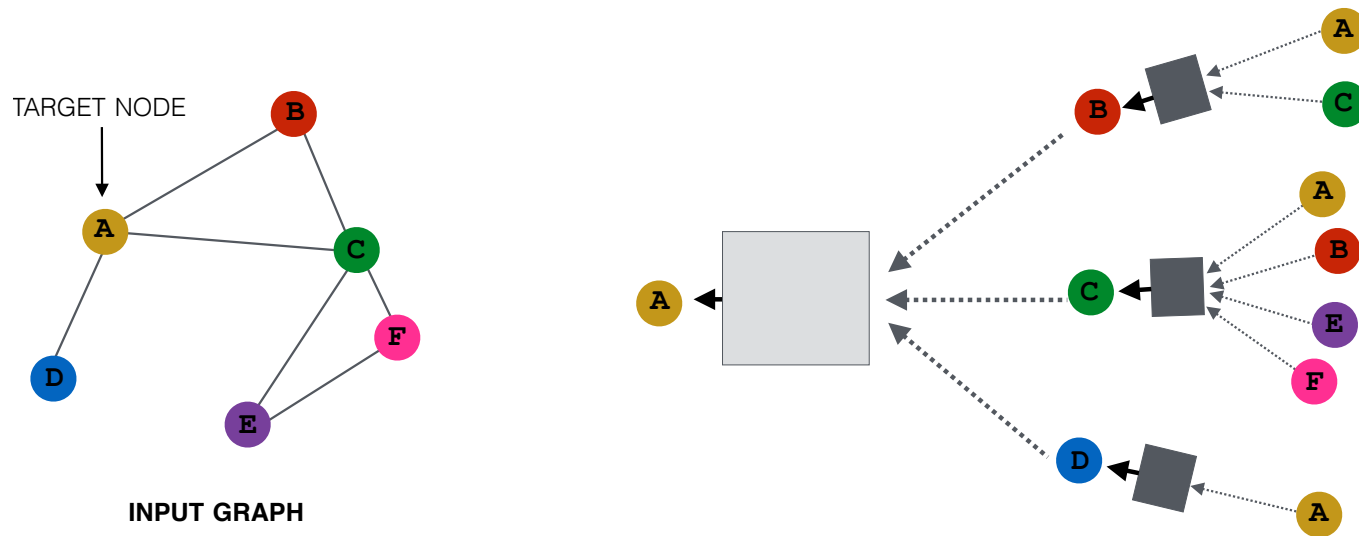

- **New idea:** (Randomly) sample a node's neighborhood for message passing

Neighborhood Sampling Example

- For example, we can randomly choose 2 neighbors to pass messages
 - Only nodes B and D will pass message to A

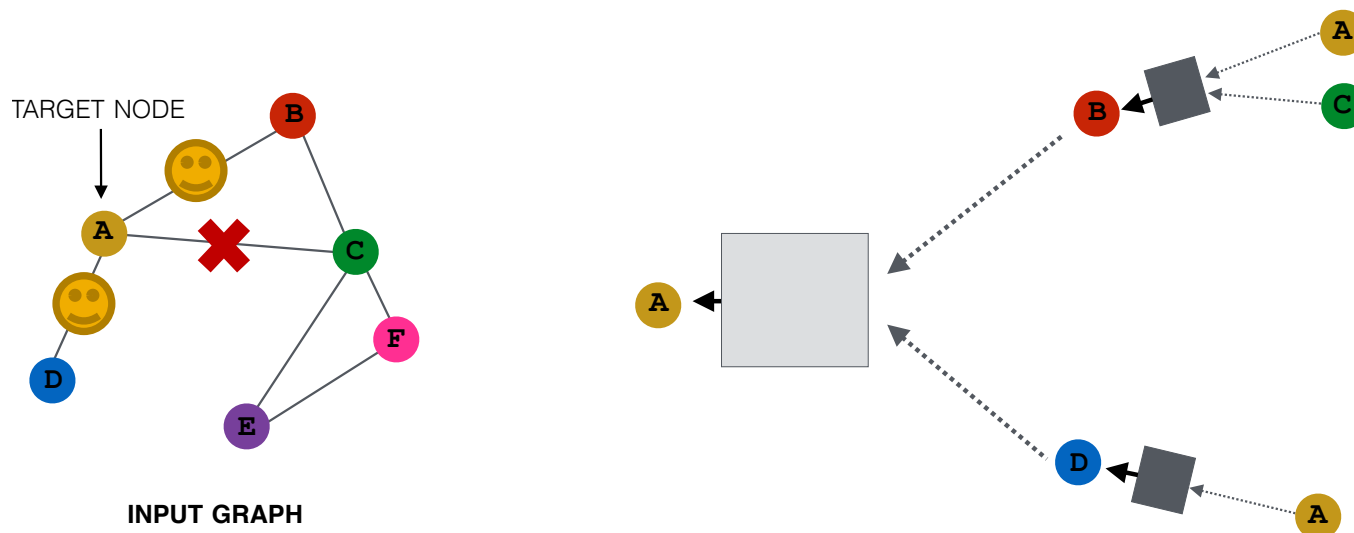

Neighborhood Sampling Example

- Next time when we compute the embeddings, we can sample different neighbors
 - Only nodes *C* and *D* will pass message to *A*

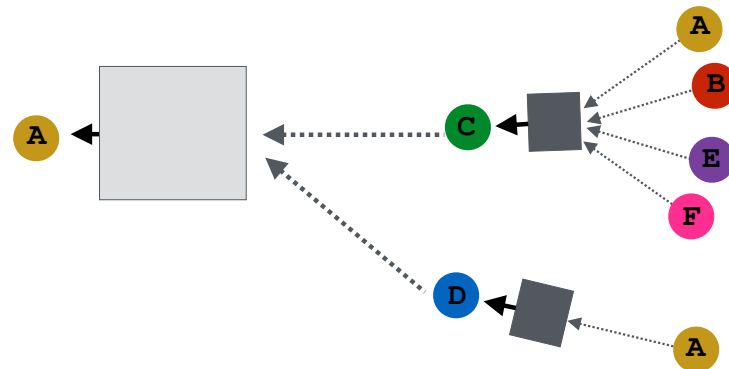
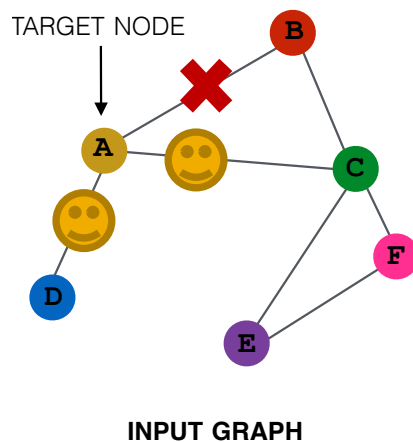

Neighborhood Sampling Example

- In expectation, we can get embeddings similar to the case where all the neighbors are used
 - **Benefits:** Greatly reduce computational cost
 - And in practice it works great!

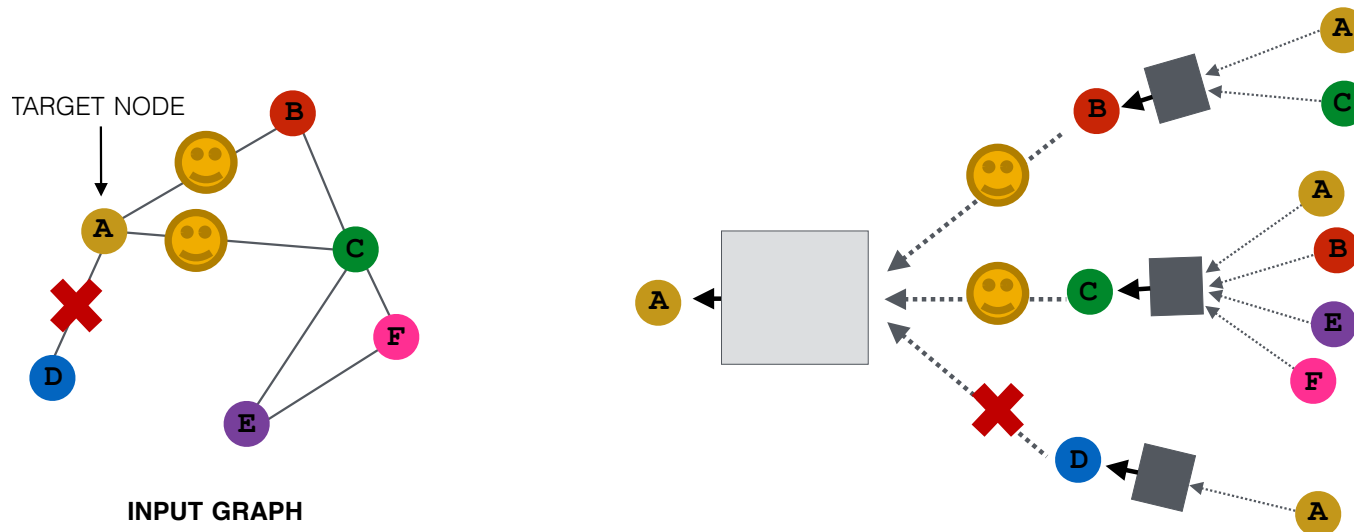

Stanford CS224W: Prediction with GNNs

CS224W: Machine Learning with Graphs

Jure Leskovec, Stanford University

<http://cs224w.stanford.edu>



A General GNN Framework (4)

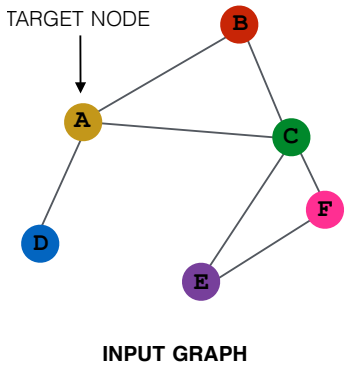

(5) Learning objective

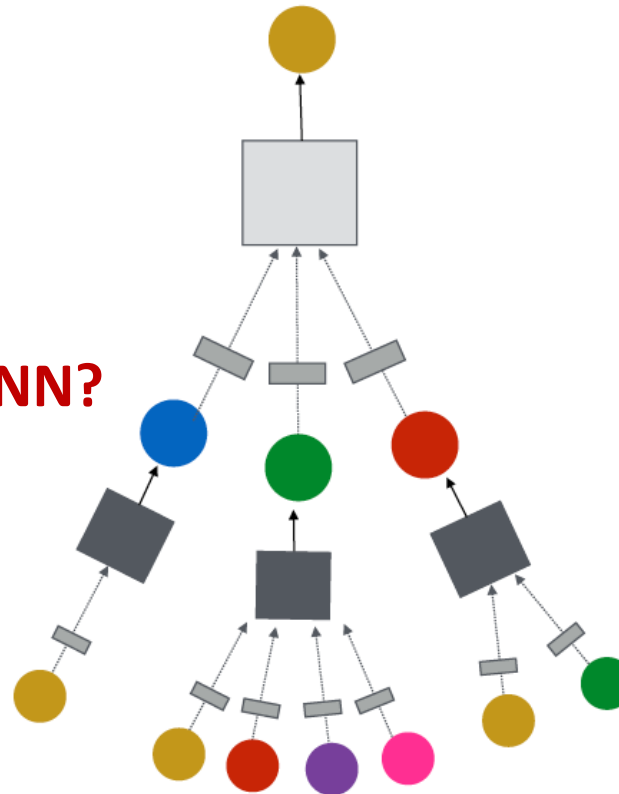

Next: How do we train a GNN?

GNN Training Pipeline

So far what we have covered

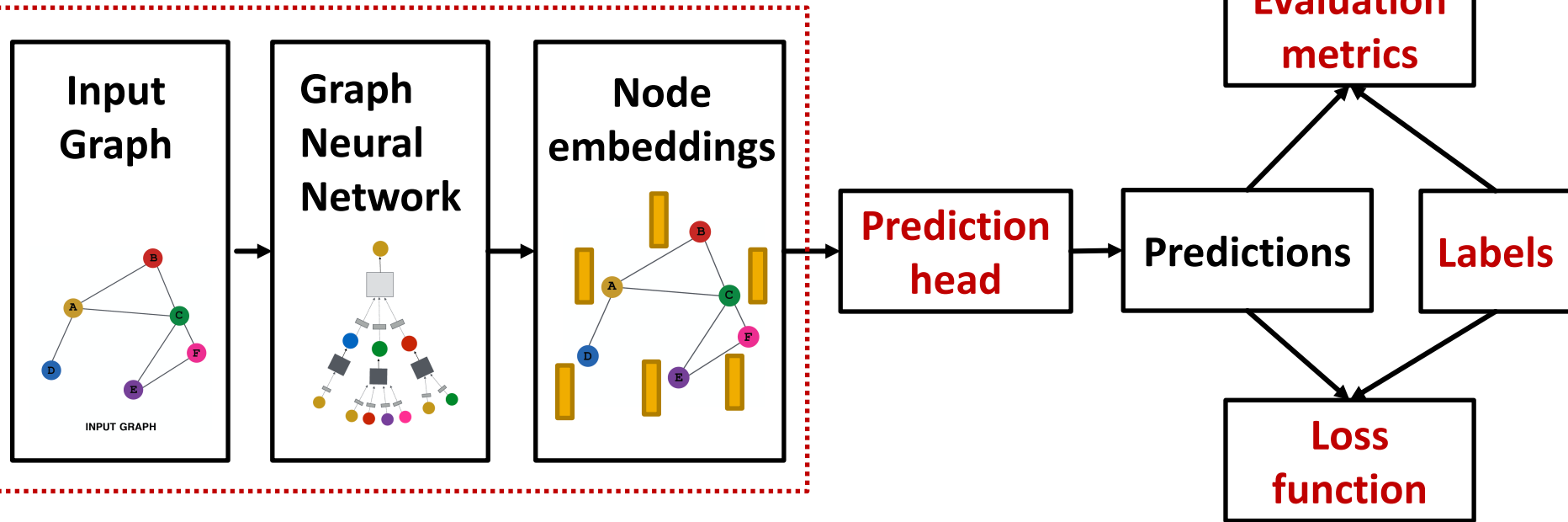

Output of a GNN: set of node embeddings

$$\{\mathbf{h}_v^{(L)}, \forall v \in G\}$$

GNN Training Pipeline (1)

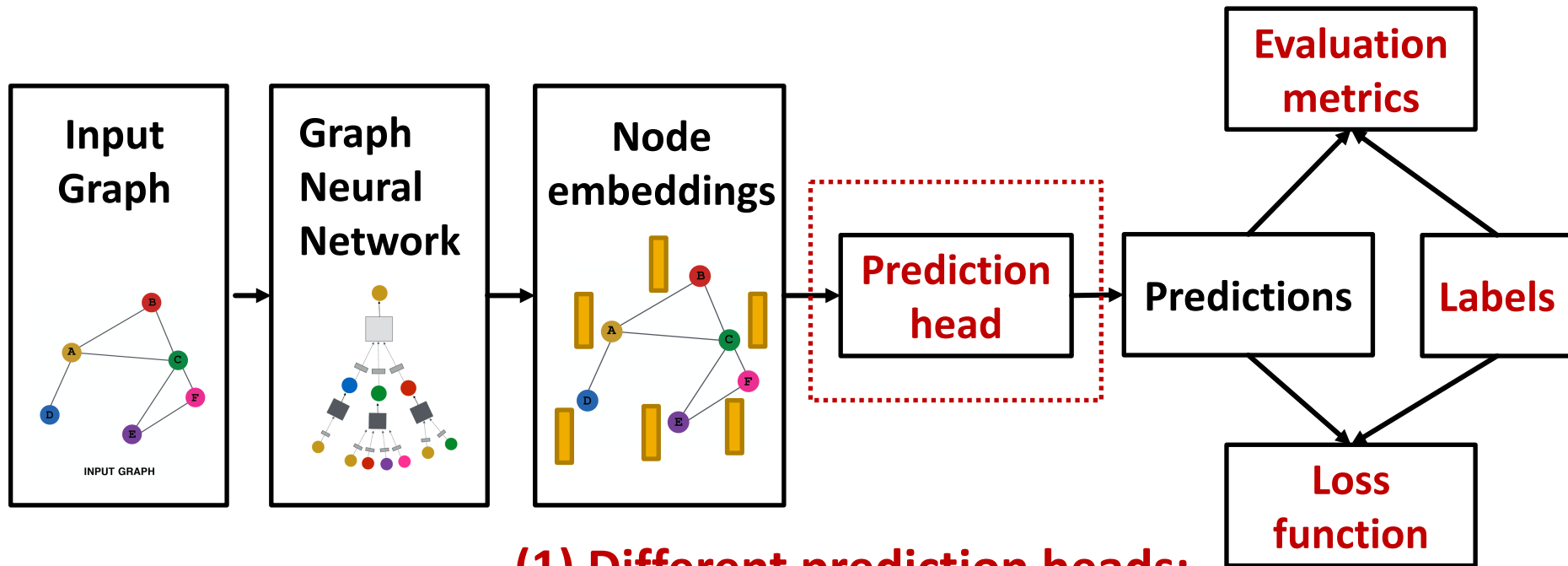

(1) Different prediction heads:

- Node-level tasks
- Edge-level tasks
- Graph-level tasks

GNN Prediction Heads

- **Idea:** Different task levels require different prediction heads

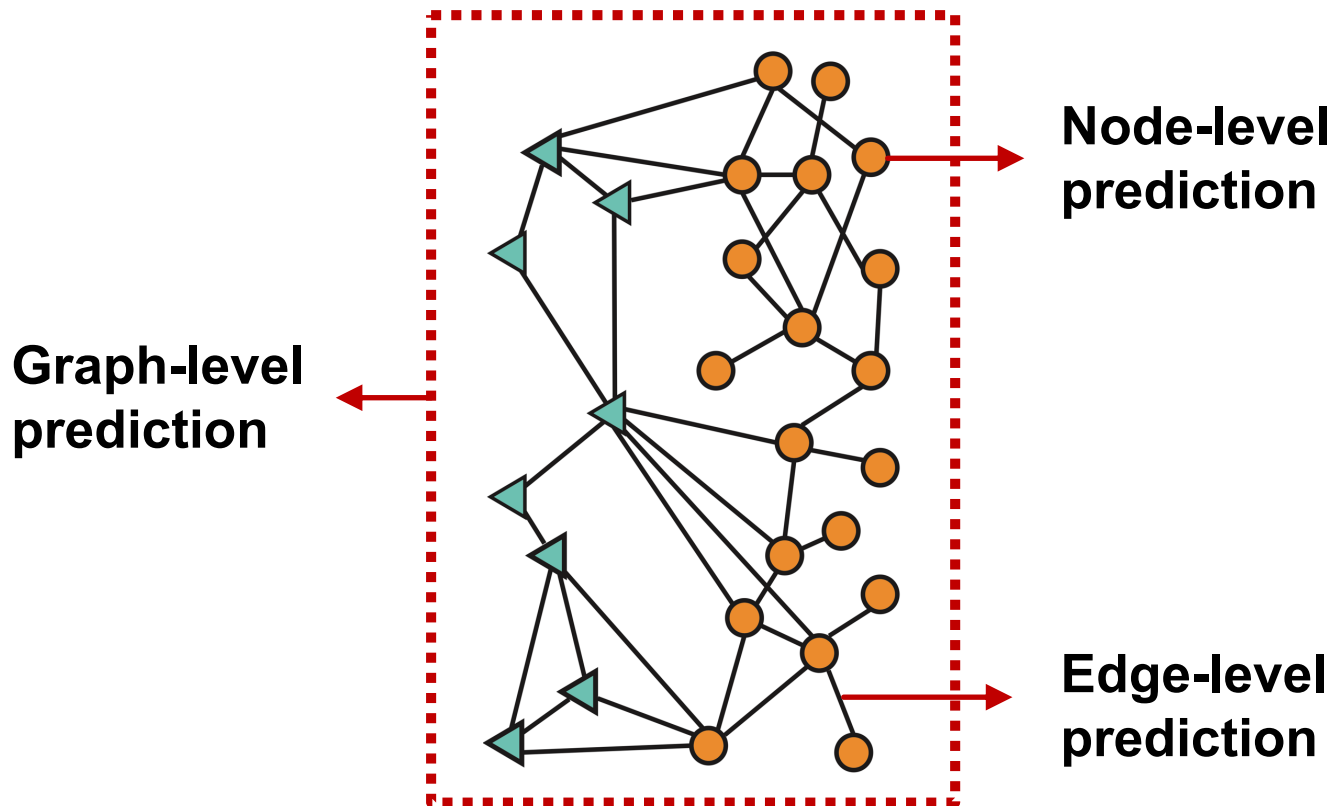

Prediction Heads: Node-level

- **Node-level prediction**: We can directly make prediction using node embeddings!
- After GNN computation, we have **d -dim node embeddings**: $\{\mathbf{h}_v^{(L)} \in \mathbb{R}^d, \forall v \in G\}$
- Suppose we want to make **k -way prediction**
 - Classification: classify among k categories
 - Regression: regress on k targets
- $\hat{\mathbf{y}}_v = \text{Head}_{\text{node}}(\mathbf{h}_v^{(L)}) = \mathbf{W}^{(H)} \mathbf{h}_v^{(L)}$
 - $\mathbf{W}^{(H)} \in \mathbb{R}^{k \times d}$: We map node embeddings from $\mathbf{h}_v^{(L)} \in \mathbb{R}^d$ to $\hat{\mathbf{y}}_v \in \mathbb{R}^k$ so that we can compute the loss

Prediction Heads: Edge-level

- **Edge-level prediction:** Make prediction using pairs of node embeddings
- Suppose we want to make k -way prediction
- $\hat{y}_{uv} = \text{Head}_{\text{edge}}(\mathbf{h}_u^{(L)}, \mathbf{h}_v^{(L)})$

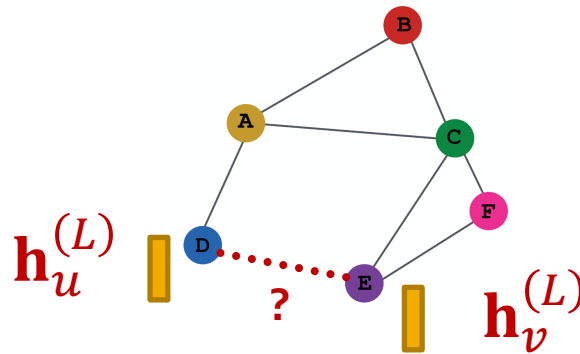

- What are the options for $\text{Head}_{\text{edge}}(\mathbf{h}_u^{(L)}, \mathbf{h}_v^{(L)})$?

Prediction Heads: Edge-level

- Options for $\text{Head}_{\text{edge}}(\mathbf{h}_u^{(L)}, \mathbf{h}_v^{(L)})$:
- **(1) Concatenation + Linear**
 - We have seen this in graph attention

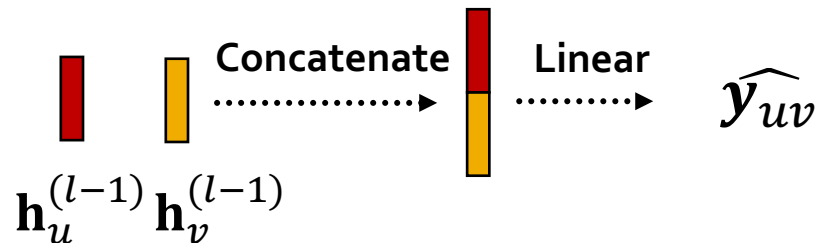

- $\hat{y}_{uv} = \text{Linear}(\text{Concat}(\mathbf{h}_u^{(L)}, \mathbf{h}_v^{(L)}))$
- Here $\text{Linear}(\cdot)$ will map **$2d$ -dimensional** embeddings (since we concatenated embeddings) to **k -dim** embeddings (k -way prediction)

Prediction Heads: Edge-level

- Options for $\text{Head}_{\text{edge}}(\mathbf{h}_u^{(L)}, \mathbf{h}_v^{(L)})$:
- **(2) Dot product**
 - $\hat{y}_{uv} = (\mathbf{h}_u^{(L)})^T \mathbf{h}_v^{(L)}$
 - This approach only applies to 1-way prediction (e.g., link prediction: predict the existence of an edge)
 - Applying to k -way prediction:
 - Similar to multi-head attention: $\mathbf{W}^{(1)}, \dots, \mathbf{W}^{(k)}$ trainable

$$\hat{y}_{uv}^{(1)} = (\mathbf{h}_u^{(L)})^T \mathbf{W}^{(1)} \mathbf{h}_v^{(L)}$$

...

$$\hat{y}_{uv}^{(k)} = (\mathbf{h}_u^{(L)})^T \mathbf{W}^{(k)} \mathbf{h}_v^{(L)}$$

$$\hat{y}_{uv} = \text{Concat}(\hat{y}_{uv}^{(1)}, \dots, \hat{y}_{uv}^{(k)}) \in \mathbb{R}^k$$

Prediction Heads: Graph-level

- **Graph-level prediction:** Make prediction using all the node embeddings in our graph
- Suppose we want to make *k*-way prediction
- $\hat{y}_G = \text{Head}_{\text{graph}}(\{\mathbf{h}_v^{(L)} \in \mathbb{R}^d, \forall v \in G\})$

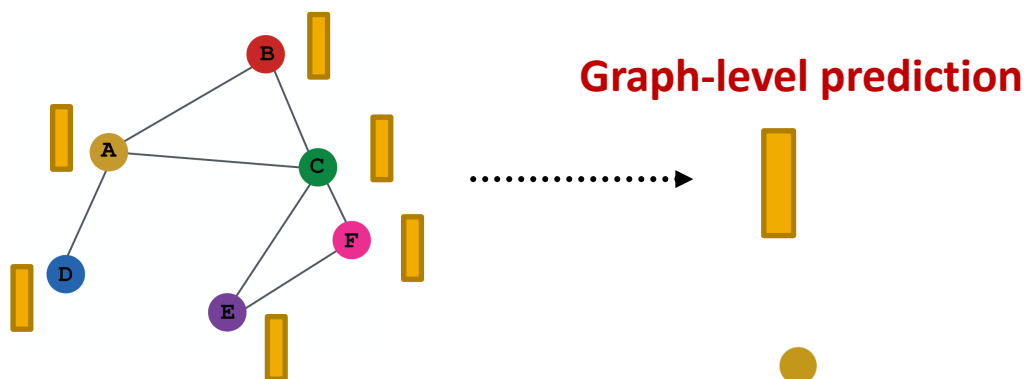

- $\text{Head}_{\text{graph}}(\cdot)$ is similar to $\text{AGG}(\cdot)$ in a GNN layer!

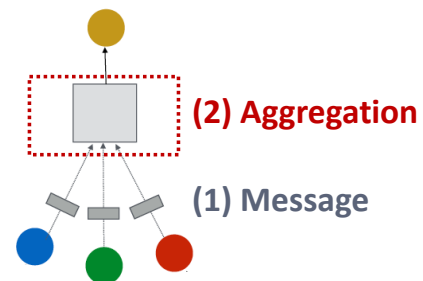

Prediction Heads: Graph-level

- Options for $\text{Head}_{\text{graph}}(\{\mathbf{h}_v^{(L)} \in \mathbb{R}^d, \forall v \in G\})$

- (1) Global mean pooling**

$$\hat{\mathbf{y}}_G = \text{Mean}(\{\mathbf{h}_v^{(L)} \in \mathbb{R}^d, \forall v \in G\})$$

- (2) Global max pooling**

$$\hat{\mathbf{y}}_G = \text{Max}(\{\mathbf{h}_v^{(L)} \in \mathbb{R}^d, \forall v \in G\})$$

- (3) Global sum pooling**

$$\hat{\mathbf{y}}_G = \text{Sum}(\{\mathbf{h}_v^{(L)} \in \mathbb{R}^d, \forall v \in G\})$$

- These options work great for small graphs
- Can we do better for large graphs?**

Stanford CS224W: Training Graph Neural Networks

CS224W: Machine Learning with Graphs

Jure Leskovec, Stanford University

<http://cs224w.stanford.edu>



GNN Training Pipeline (2)

(2) Where does ground-truth come from?

- Supervised labels
- Unsupervised signals

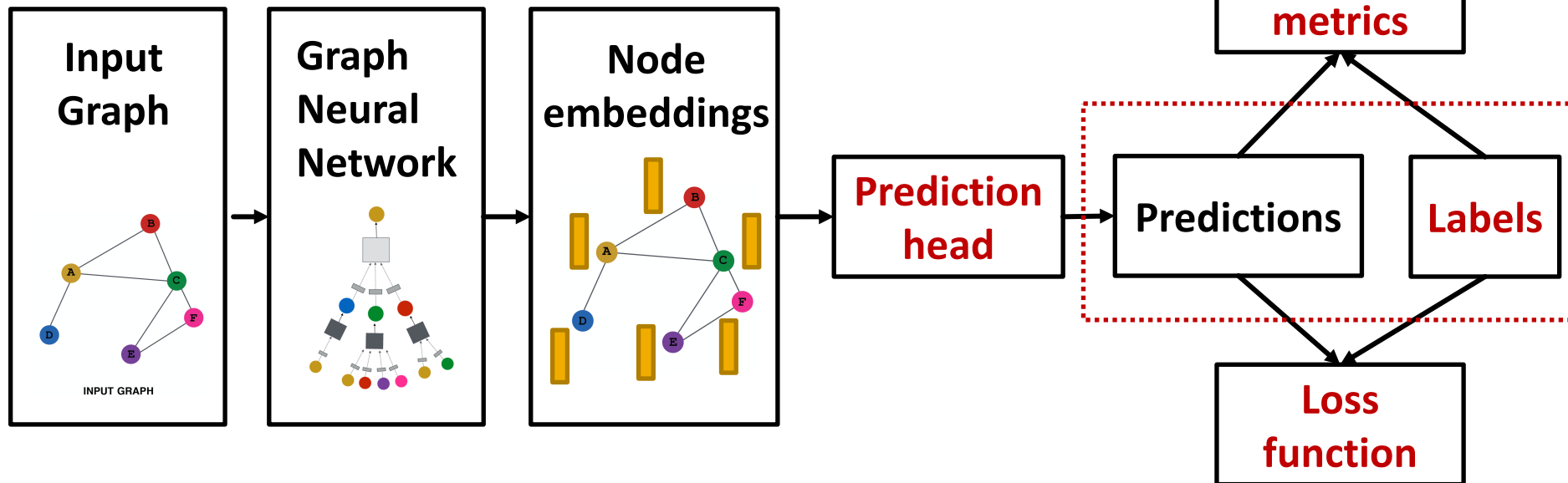

Supervised vs Unsupervised

- **Supervised learning on graphs**
 - **Labels come from external sources**
 - E.g., predict drug likeness of a molecular graph
- **Unsupervised learning on graphs**
 - **Signals come from graphs themselves**
 - E.g., link prediction: predict if two nodes are connected
- **Sometimes the differences are blurry**
 - We still have “supervision” in unsupervised learning
 - E.g., train a GNN to predict node clustering coefficient
 - An alternative name for “**unsupervised**” is “**self-supervised**”

Supervised Labels on Graphs

- **Supervised labels come from the specific use cases.** For example:
 - **Node labels y_v :** in a citation network, which subject area does a node belong to
 - **Edge labels y_{uv} :** in a transaction network, whether an edge is fraudulent
 - **Graph labels y_G :** among molecular graphs, the drug likeness of graphs
- **Advice:** Reduce your task to node / edge / graph labels, since they are easy to work with
 - **E.g.,** we knew some nodes form a cluster. We can treat the cluster that a node belongs to as a **node label**

Unsupervised Signals on Graphs

- **The problem:** sometimes we only have a graph, without any external labels
- **The solution:** “self-supervised learning”, we can find supervision signals within the graph.
 - For example, we can let **GNN predict the following:**
 - **Node-level y_v .** Node statistics: such as clustering coefficient, PageRank, ...
 - **Edge-level y_{uv} .** Link prediction: hide the edge between two nodes, predict if there should be a link
 - **Graph-level y_G .** Graph statistics: for example, predict if two graphs are isomorphic
 - **These tasks do not require any external labels!**

GNN Training Pipeline (3)

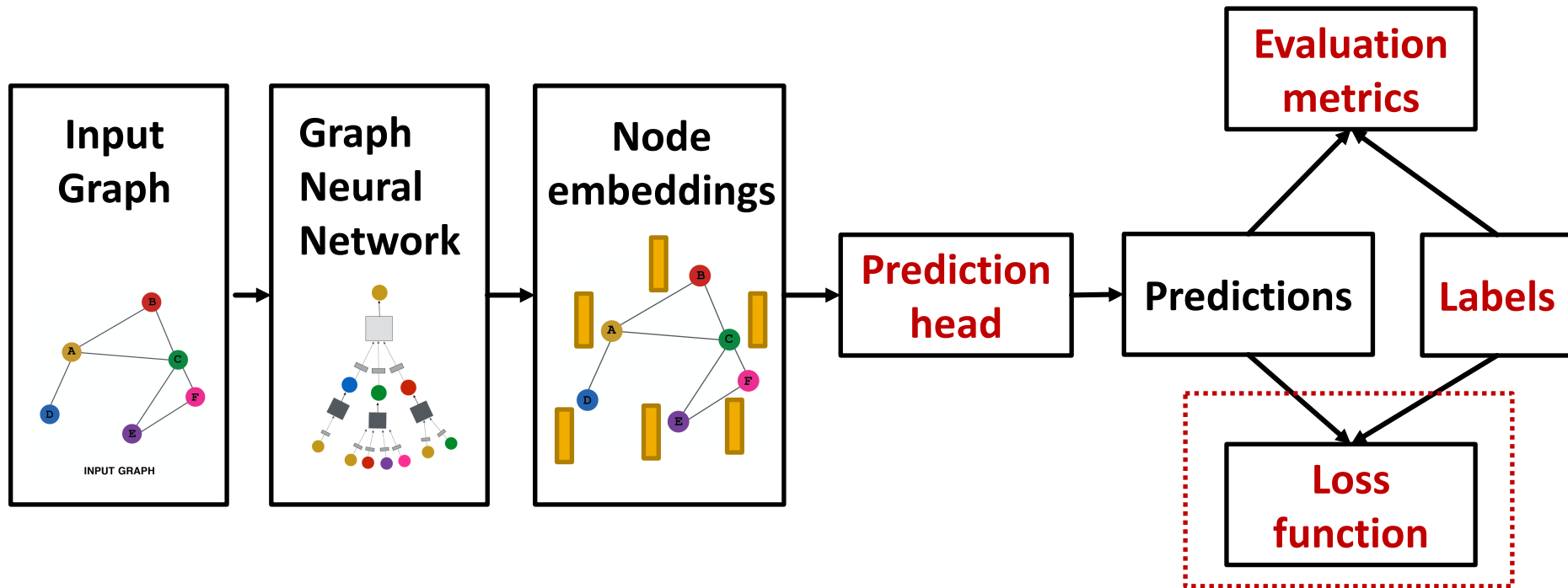

(3) How do we compute the final loss?

- **Classification loss**
- **Regression loss**

Settings for GNN Training

- **The setting:** We have N data points
 - Each data point can be a node/edge/graph
 - **Node-level:** prediction $\hat{\mathbf{y}}_v^{(i)}$, label $\mathbf{y}_v^{(i)}$
 - **Edge-level:** prediction $\hat{\mathbf{y}}_{uv}^{(i)}$, label $\mathbf{y}_{uv}^{(i)}$
 - **Graph-level:** prediction $\hat{\mathbf{y}}_G^{(i)}$, label $\mathbf{y}_G^{(i)}$
 - We will use prediction $\hat{\mathbf{y}}^{(i)}$, label $\mathbf{y}^{(i)}$ to refer **predictions at all levels**

Classification or Regression

- **Classification:** labels $\mathbf{y}^{(i)}$ with discrete value
 - E.g., Node classification: which category does a node belong to
- **Regression:** labels $\mathbf{y}^{(i)}$ with continuous value
 - E.g., predict the drug likeness of a molecular graph
- GNNs can be applied to both settings
- **Differences: loss function & evaluation metrics**

Classification Loss

- As discussed in lecture 6, **cross entropy (CE)** is a very common loss function in classification
- **K -way prediction** for i -th data point:

$$\text{CE}(\underbrace{\mathbf{y}^{(i)}}_{\text{Label}}, \underbrace{\hat{\mathbf{y}}^{(i)}}_{\text{Prediction}}) = - \sum_{j=1}^K \mathbf{y}_j^{(i)} \log(\hat{\mathbf{y}}_j^{(i)})$$

i -th data point
 j -th class

where:

E.g.

0	0	1	0	0
---	---	---	---	---

$\mathbf{y}^{(i)} \in \mathbb{R}^K =$ one-hot label encoding

$\hat{\mathbf{y}}^{(i)} \in \mathbb{R}^K =$ prediction after Softmax(\cdot)

E.g.

0.1	0.3	0.4	0.1	0.1
-----	-----	-----	-----	-----

- **Total loss over all N training examples**

$$\text{Loss} = \sum_{i=1}^N \text{CE}(\mathbf{y}^{(i)}, \hat{\mathbf{y}}^{(i)})$$

Regression Loss

- For regression tasks we often use **Mean Squared Error (MSE)** a.k.a. **L2 loss**
- *K*-way regression for data point (*i*):

$$\text{MSE}(\mathbf{y}^{(i)}, \hat{\mathbf{y}}^{(i)}) = \sum_{j=1}^K (\mathbf{y}_j^{(i)} - \hat{\mathbf{y}}_j^{(i)})^2$$

i-th data point
j-th target

where:

E.g.

1.4	2.3	1.0	0.5	0.6
-----	-----	-----	-----	-----

$\mathbf{y}^{(i)} \in \mathbb{R}^k$ = Real valued vector of targets
 $\hat{\mathbf{y}}^{(i)} \in \mathbb{R}^k$ = Real valued vector of predictions

E.g.

0.9	2.8	2.0	0.3	0.8
-----	-----	-----	-----	-----

- Total loss over all *N* training examples

$$\text{Loss} = \sum_{i=1}^N \text{MSE}(\mathbf{y}^{(i)}, \hat{\mathbf{y}}^{(i)})$$

GNN Training Pipeline (4)

(4) How do we measure the success of a GNN?

- Accuracy
- ROC AUC

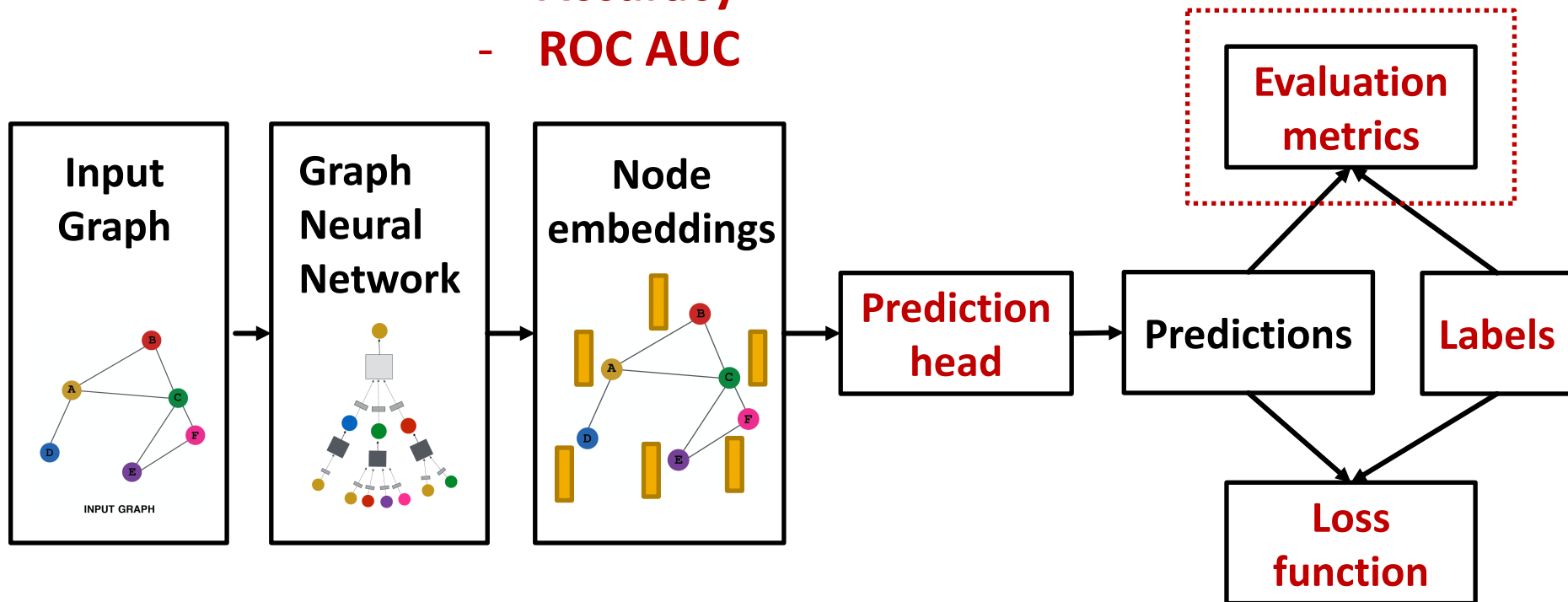

Evaluation Metrics: Regression

- **We use standard evaluation metrics for GNN**
 - (Content below can be found in any ML course)
 - In practice we will use [sklearn](#) for implementation
 - Suppose we make predictions for N data points
- **Evaluate regression tasks on graphs:**
 - **Root mean square error (RMSE)**

$$\sqrt{\sum_{i=1}^N \frac{(\mathbf{y}^{(i)} - \hat{\mathbf{y}}^{(i)})^2}{N}}$$

- **Mean absolute error (MAE)**

$$\frac{\sum_{i=1}^N |\mathbf{y}^{(i)} - \hat{\mathbf{y}}^{(i)}|}{N}$$

Evaluation Metrics: Classification

- Evaluate classification tasks on graphs:
- (1) Multi-class classification

- We simply report the accuracy

$$\frac{1[\operatorname{argmax}(\hat{\mathbf{y}}^{(i)}) = \mathbf{y}^{(i)}]}{N}$$

- (2) Binary classification

- Metrics sensitive to classification threshold
 - Accuracy
 - Precision / Recall
 - If the range of prediction is $[0,1]$, we will use 0.5 as threshold
- Metric Agnostic to classification threshold
 - **ROC AUC**

Metrics for Binary Classification

- **Accuracy:**

$$\frac{TP + TN}{TP + TN + FP + FN} = \frac{TP + TN}{|\text{Dataset}|}$$

- **Precision (P):**

$$\frac{TP}{TP + FP}$$

- **Recall (R):**

$$\frac{TP}{TP + FN}$$

- **F1-Score:**

$$\frac{2P * R}{P + R}$$

Confusion matrix

	Actually Positive (1)	Actually Negative (0)
Predicted Positive (1)	True Positives (TPs)	False Positives (FPs)
Predicted Negative (0)	False Negatives (FNs)	True Negatives (TNs)

(4) Evaluation Metrics

- **ROC Curve:** Captures the tradeoff in TPR and FPR as the classification threshold is varied for a binary classifier.

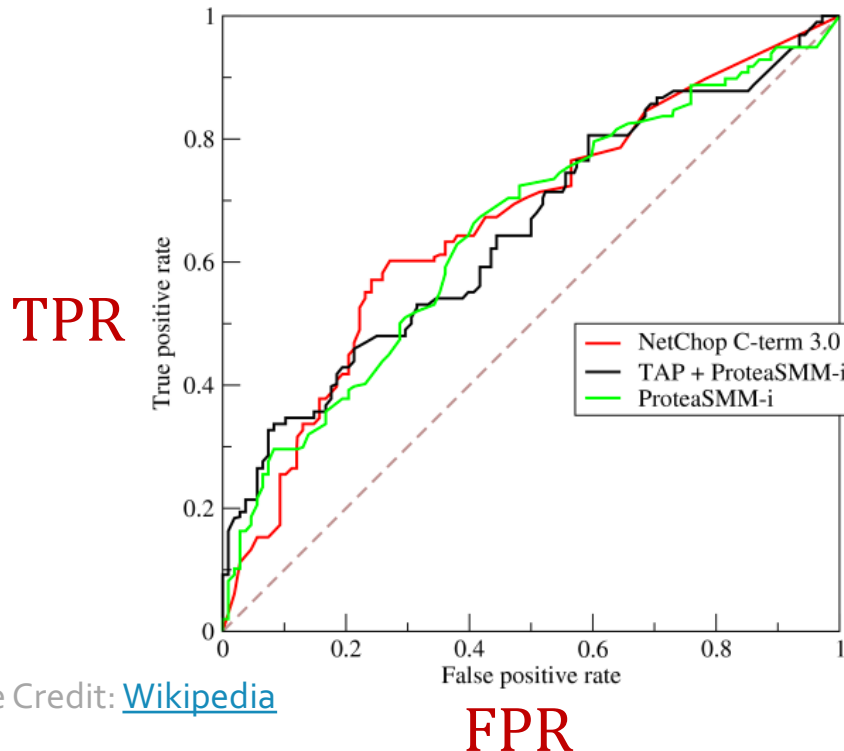

Image Credit: [Wikipedia](https://en.wikipedia.org/wiki/Receiver_operating_characteristic)

$$\text{TPR} = \text{Recall} = \frac{\text{TP}}{\text{TP} + \text{FN}}$$

$$\text{FPR} = \frac{\text{FP}}{\text{FP} + \text{TN}}$$

Note: the dashed line represents performance of a random classifier

(4) Evaluation Metrics

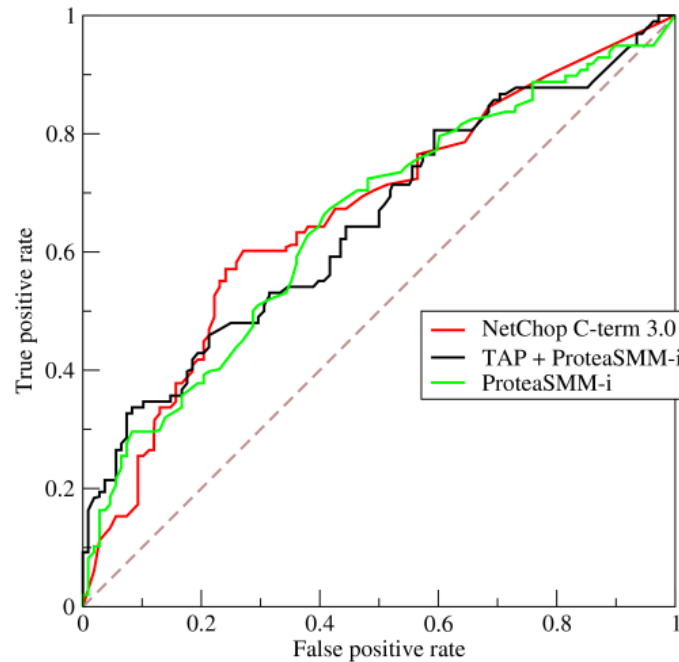

Content Credit: [Wikipedia](https://en.wikipedia.org/wiki/ROC_curve)

- **ROC AUC: Area under the ROC Curve.**
- **Intuition:** The probability that a classifier will rank a randomly chosen positive instance higher than a randomly chosen negative one

Stanford CS224W: Setting-up GNN Prediction Tasks

CS224W: Machine Learning with Graphs

Jure Leskovec, Stanford University

<http://cs224w.stanford.edu>



GNN Training Pipeline (5)

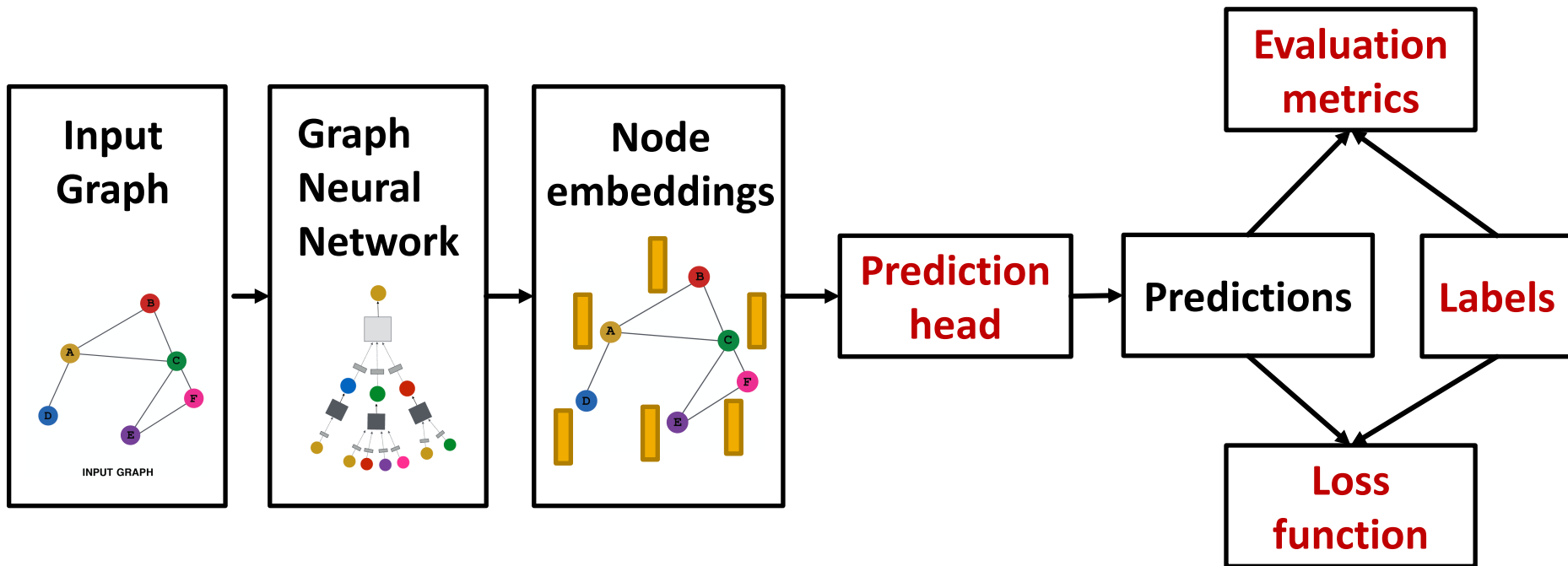

(5) How do we split our dataset into train / validation / test set?

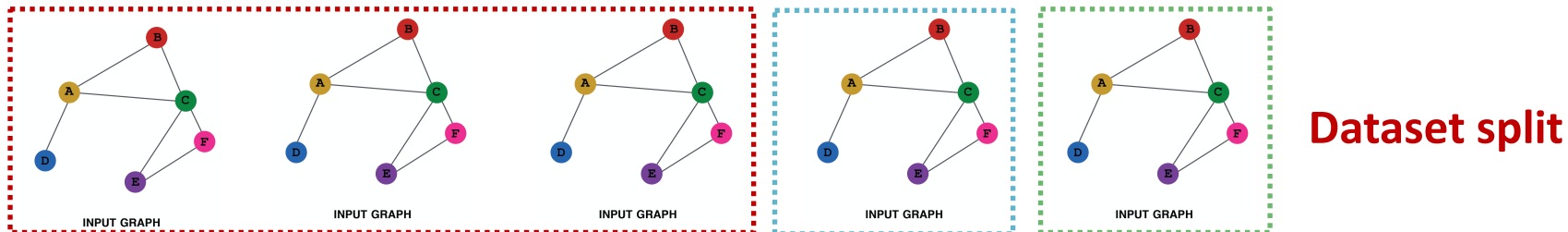

Dataset Split: Fixed / Random Split

- **Fixed split:** We will split our dataset **once**
 - **Training set:** used for optimizing GNN parameters
 - **Validation set:** develop model/hyperparameters
 - **Test set:** held out until we report final performance
- **A concern:** sometimes we cannot guarantee that the test set will really be held out
- **Random split:** we will **randomly split** our dataset into training / validation / test
 - We report **average performance over different random seeds**

Why Splitting Graphs is Special

- **Suppose we want to split an image dataset**
 - **Image classification:** Each data point is an image
 - Here **data points are independent**
 - Image 5 will not affect our prediction on image 1

Training

Validation

Test

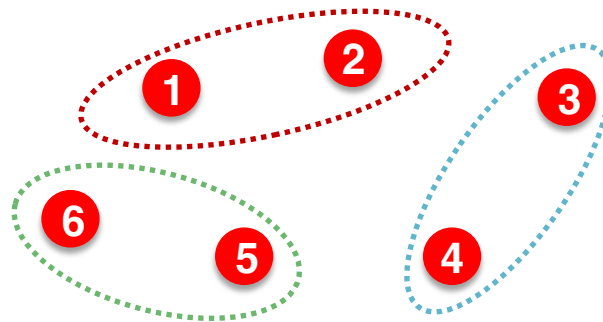

Why Splitting Graphs is Special

- **Splitting a graph dataset is different!**
 - **Node classification:** Each data point is a node
 - Here **data points are NOT independent**
 - **Node 5 will affect our prediction on node 1**, because it will participate in message passing → affect node 1's embedding

Training

Validation

Test

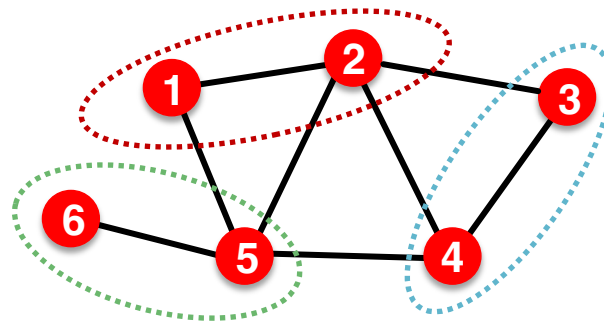

- **What are our options?**

Why Splitting Graphs is Special

- **Solution 1 (Transductive setting):** The input graph can be observed in all the dataset splits (training, validation and test set).
- **We will only split the (node) labels**
 - **At training time**, we compute embeddings using the entire graph, and train using node 1&2's labels
 - **At validation time**, we compute embeddings using the entire graph, and evaluate on node 3&4's labels

Training

Validation

Test

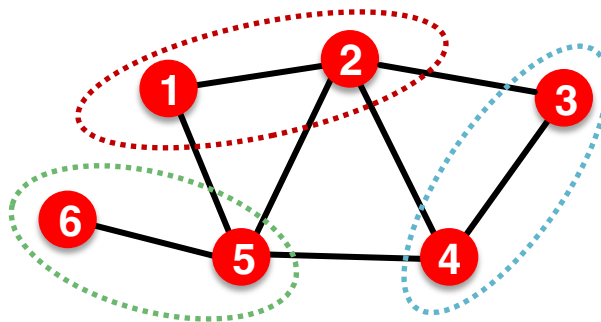

Why Splitting Graphs is Special

- **Solution 2 (Inductive setting):** We break the edges between splits **to get multiple graphs**
 - **Now we have 3 graphs that are independent.** Node 5 will not affect our prediction on node 1 any more
 - **At training time,** we compute embeddings **using the graph over node 1&2,** and train **using node 1&2's labels**
 - **At validation time,** we compute embeddings **using the graph over node 3&4,** and **evaluate on node 3&4's labels**

Training

Validation

Test

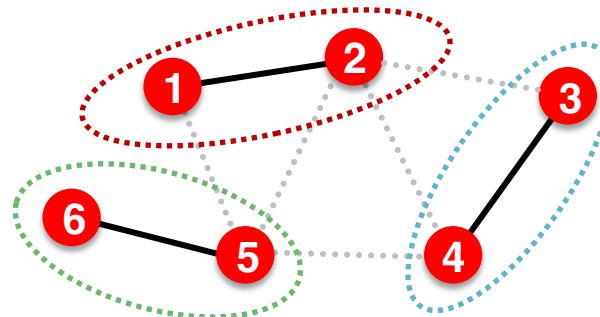

Transductive / Inductive Settings

- **Transductive setting:** training / validation / test sets are **on the same graph**
 - The **dataset consists of one graph**
 - **The entire graph can be observed in all dataset splits, we only split the labels**
 - Only applicable to **node / edge** prediction tasks
- **Inductive setting:** training / validation / test sets are **on different graphs**
 - The **dataset consists of multiple graphs**
 - Each split can **only observe the graph(s) within the split**. A successful model should **generalize to unseen graphs**
 - Applicable to **node / edge / graph** tasks

Example: Node Classification

- **Transductive node classification**
 - All the splits can observe the entire graph structure, but can only observe the labels of their respective nodes

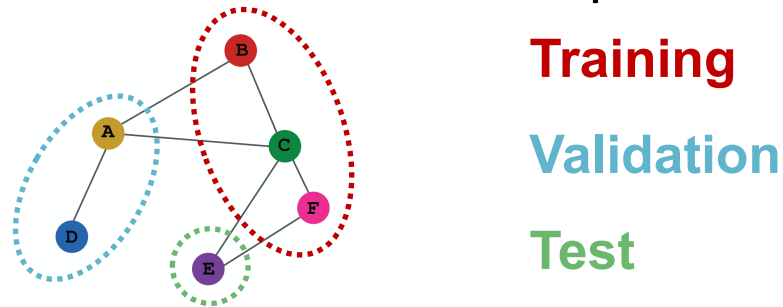

- **Inductive node classification**
 - Suppose we have a dataset of 3 graphs
 - Each split contains an independent graph

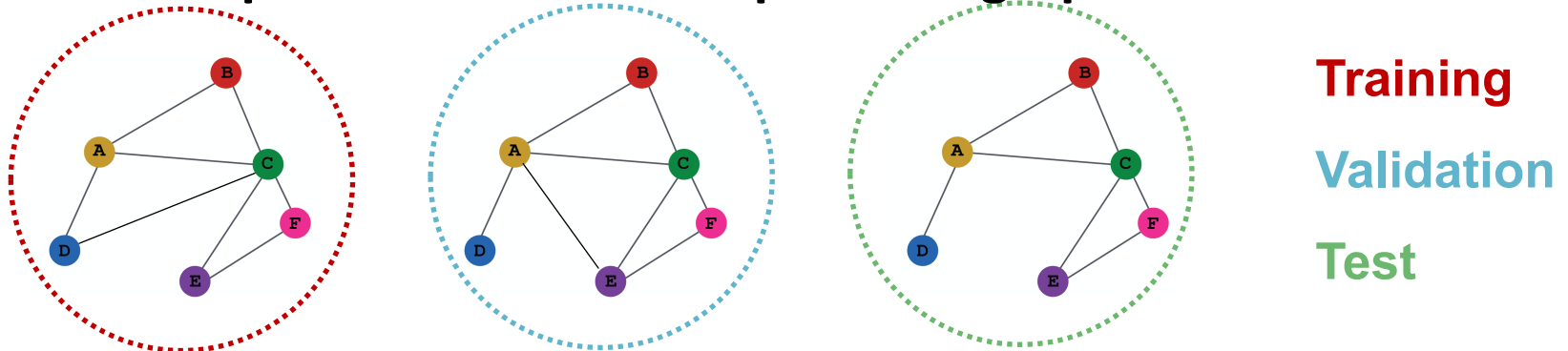

Example: Graph Classification

- Only the **inductive setting** is well defined for **graph classification**
 - Because **we have to test on unseen graphs**
 - Suppose we have a dataset of 5 graphs. Each split will contain independent graph(s).

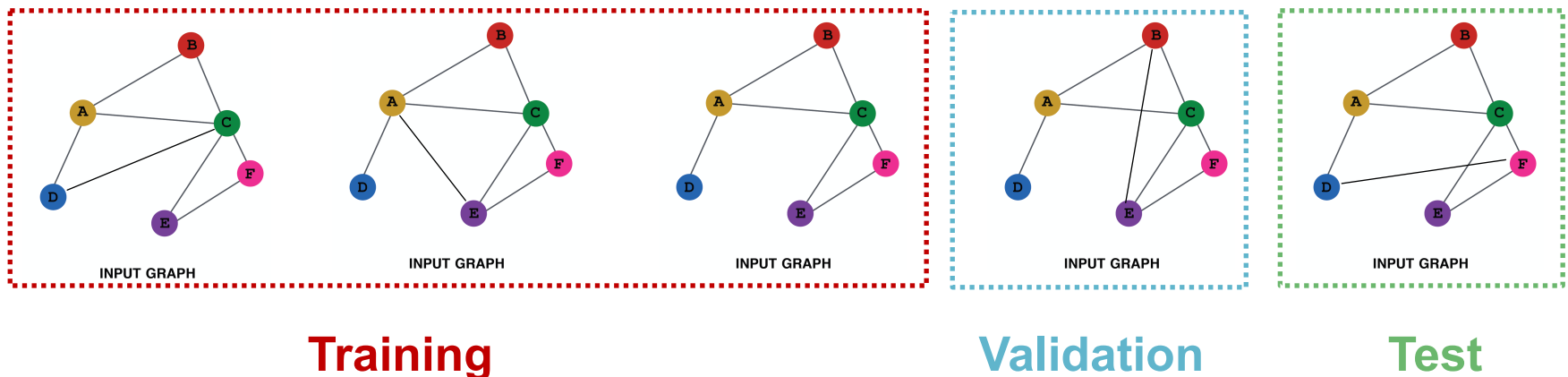

Example: Link Prediction

- **Goal of link prediction:** predict missing edges
- **Setting up link prediction is tricky:**
 - Link prediction is an unsupervised / self-supervised task. We need to **create the labels** and **dataset splits** on our own
 - Concretely, we need to **hide some edges from the GNN** and **let the GNN predict if the edges exist**

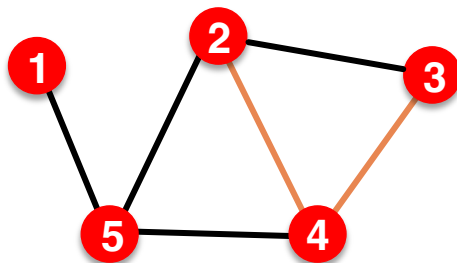

Original graph

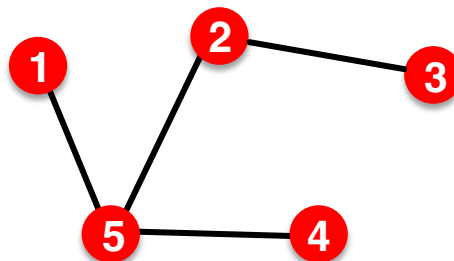

Input graph to GNN

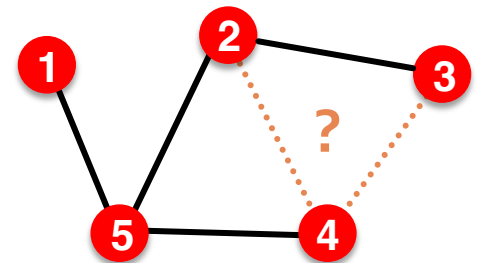

Predictions made by GNN

Setting up Link Prediction

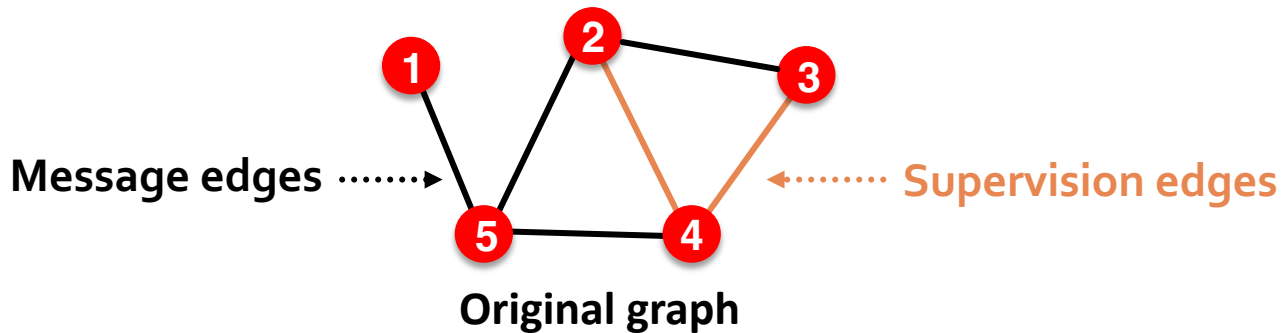

- For link prediction, we will split edges twice
- Step 1: Assign 2 types of edges in the original graph
 - Message edges: Used for GNN message passing
 - Supervision edges: Use for computing objectives
 - After step 1:
 - Only message edges will remain in the graph
 - Supervision edges are used as supervision for edge predictions made by the model, will not be fed into GNN!

Setting up Link Prediction

- **Step 2: Split edges into train / validation / test**
- **Option 1: Inductive link prediction split**
 - Suppose we have a dataset of 3 graphs. Each inductive split will contain an independent graph

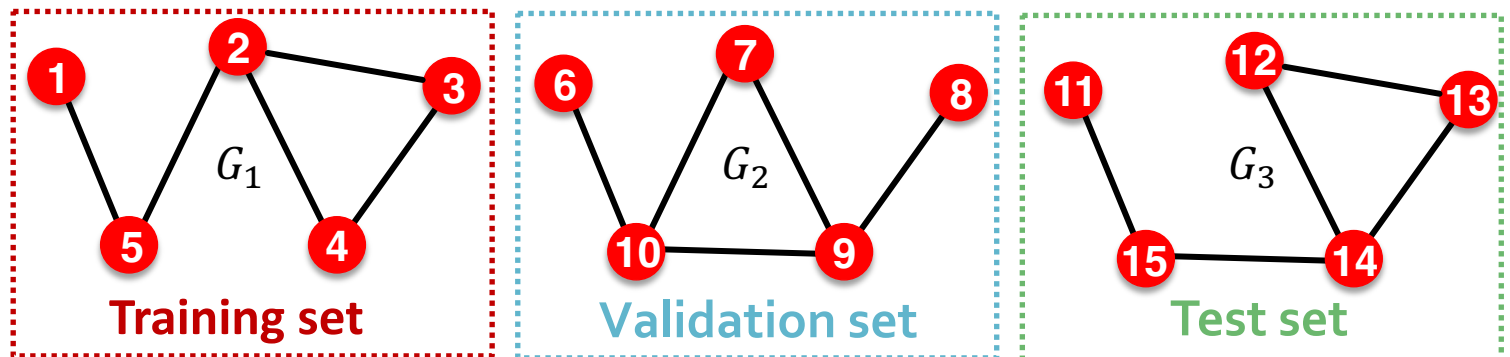

Setting up Link Prediction

- **Step 2: Split edges into train / validation / test**
- **Option 1: Inductive link prediction split**
 - Suppose we have a dataset of 3 graphs. Each inductive split will contain an independent graph
 - In **train** or **val** or **test** set, each graph will have **2** types of edges: message edges + supervision edges
 - **Supervision edges** are not the input to GNN

Message edge ———

Supervision edge ·····

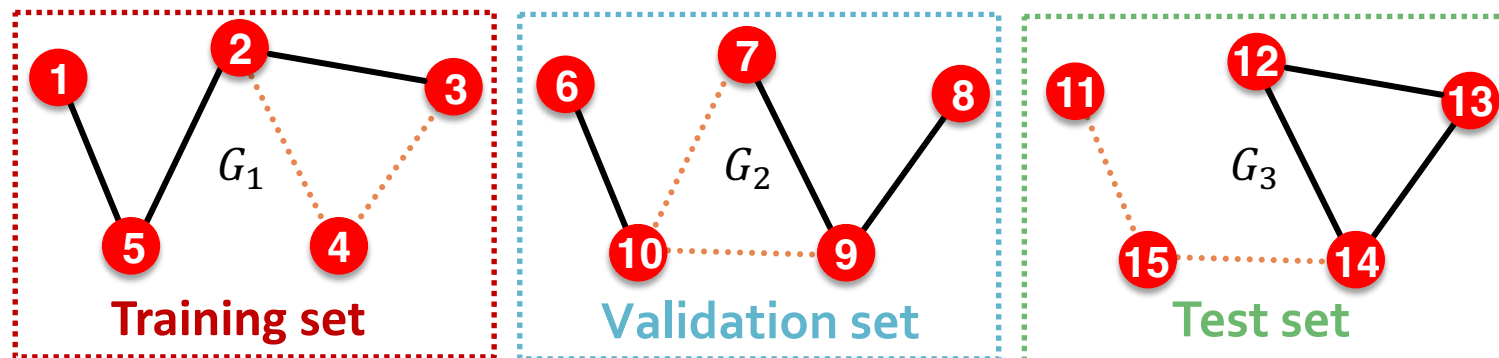

Setting up Link Prediction

- **Option 2: Transductive link prediction split:**
 - This is the default setting when people talk about link prediction
 - Suppose we have a dataset of 1 graph

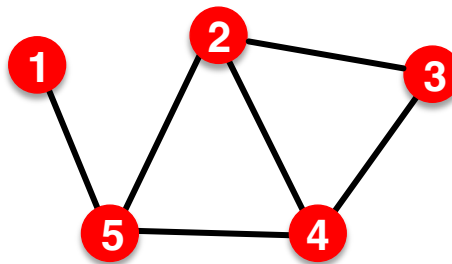

Setting up Link Prediction

- **Option 2: Transductive link prediction split:**
 - By definition of “transductive”, the entire graph can be observed in all dataset splits
 - But since edges are both part of graph structure and the supervision, we need to hold out **validation / test** edges
 - To train the **training** set, we further need to hold out **supervision edges** for the **training** set

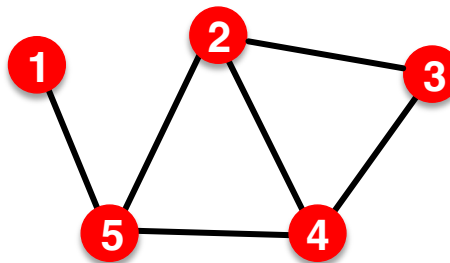

- **Next:** we will show the exact settings

Setting up Link Prediction

■ Option 2: Transductive link prediction split:

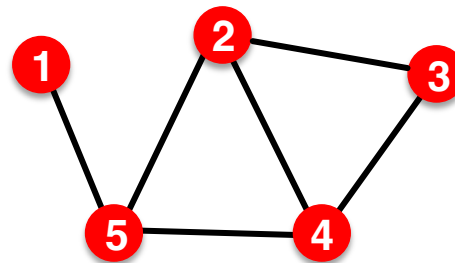

The original graph

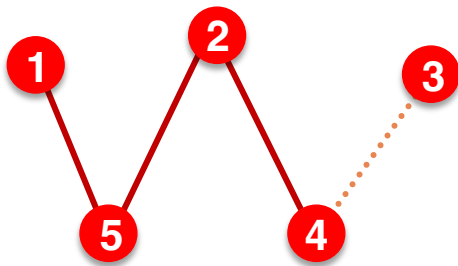

(1) At training time:
Use **training message edges** to predict **training supervision edges**

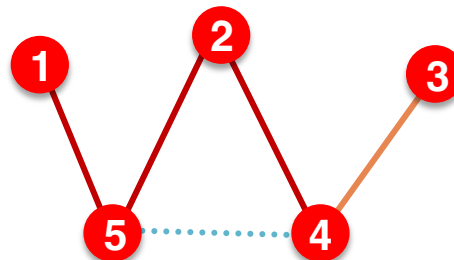

(2) At validation time:
Use **training message edges & training supervision edges** to predict **validation edges**

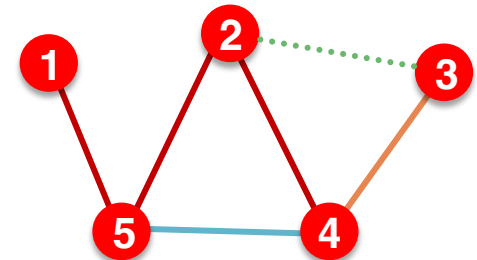

(3) At test time:
Use **training message edges & training supervision edges & validation edges** to predict **test edges**

Setting up Link Prediction

■ Option 2: Transductive link prediction split:

Why do we use growing number of edges?

After training, supervision edges are known to GNN.

Therefore, an ideal model should use supervision edges in message passing at validation time.

The same applies to the test time.

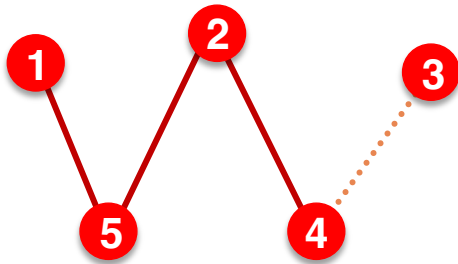

(1) At training time:
Use **training message edges** to predict **training supervision edges**

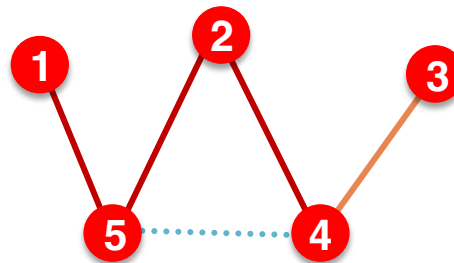

(2) At validation time:
Use **training message edges & training supervision edges** to predict **validation edges**

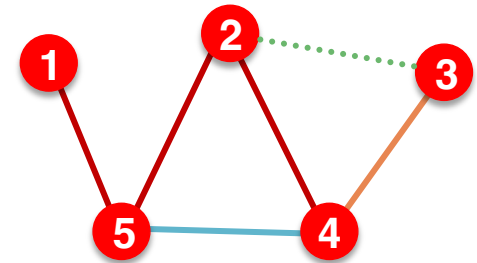

(3) At test time:
Use **training message edges & training supervision edges & validation edges** to predict **test edges**

Setting up Link Prediction

■ Summary: Transductive link prediction split:

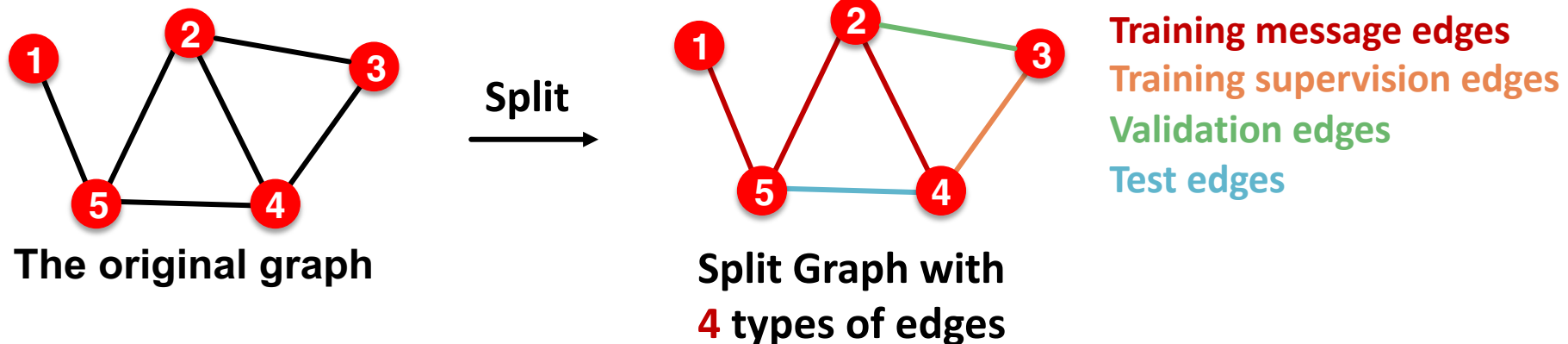

- **Note:** Link prediction settings are tricky and complex. You may find papers do link prediction differently.
- Luckily, we have full support in **PyG** and [GraphGym](#)

GNN Training Pipeline

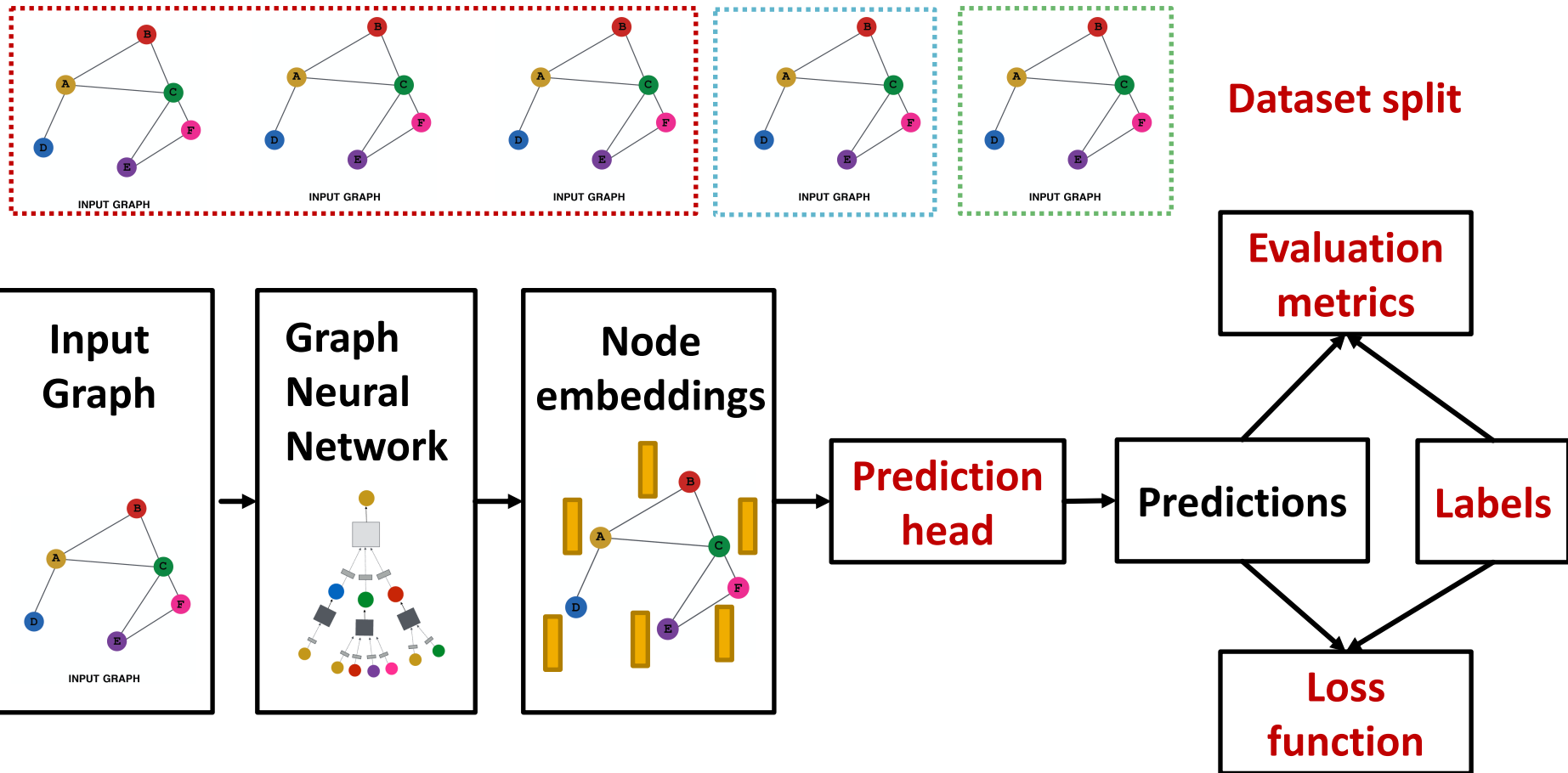

Implementation resources:

[GraphGym](#) further implements the full pipeline to facilitate GNN design

Summary of the Lecture

- We introduce **a general GNN framework:**
 - **GNN Layer:**
 - Transformation + Aggregation
 - Classic GNN layers: GCN, GraphSAGE, GAT
 - **Layer connectivity:**
 - The over-smoothing problem
 - Solution: skip connections
 - **Graph Augmentation:**
 - Feature augmentation
 - Structure augmentation
 - **Learning Objectives**
 - The full training pipeline of a GNN